



The Catalogue

VMZINC[®] Ornaments

The Catalogue VMZINC® Ornaments



Contents

Tradition and Service	5
The heirs of an art	5
Unique know-how	7
Finials, fire urns, pinnacles and flames	9
> Finials, fire urns, pinnacles, and flames	10
> Traditional finials	14
> Standard finials	15
> Standard finials, pinnacles, flames	18
Square finials	18
Pinnacle finials	18
> Finials	19
Modified bases	19
Bespoke bases	19
Fixing rods	19
Weathervanes and compositions	21
> Weathervanes and compositions	22
Compositions	24
Standard compositions	25
> Weathervanes	28
Referenced stamped cockerels	29
Stamped cockerel assembly	30
Standard stamped weathervanes	31
Standard cut weathervanes	32
Standard arrows and flags	32
> Standard cardinal points	33
Major structures	35
> Domes, campaniles, arrows, kiosks	36

Bull's eyes and dormer windows 39

- > **Bull's eyes and dormer windows 40**
- > **Standard bull's eyes and dormer windows 46**
 - Joinery 47
 - Elements required for a quote 48
- > **Standard dormer windows 49**
 - Elements required for a quote 50
- > **Standard key accessories 51**

Smooth and stamped profiles 53

- > **Smooth and stamped profiles 54**
- > **Straight smooth profiles 56**
 - Standard cover strips 56
 - Standard gutter fronts 57
 - Standard hand rails 58
- > **Curved smooth profiles 59**
- > **Standard stamped profiles 60**
 - Cover strips 60
 - Gutter fronts - Escutcheons 60

Stamped designs 61

- > **Stamped designs 62**
 - Standard double ridges 62
- > **Standard stamped designs 67**
 - Awnings 68
 - Valances 68
 - Hips and beads 69
 - Roses 69
 - Leaves 70
 - Heads 70

Roofing, facade and other products 71

- > **Shingles 72**
 - Decorative, stamped shingles 72
 - Soletos 72
 - Bespoke stamped shingles 73
 - Various format and aesthetic shingles 74
 - Bespoke shingles 75
 - Customised shingles 77
- > **Stamped standing seam 78**
- > **Stamped panels 79**
- > **Decorated facades 80**
- > **Balustrades 81**
- > **Other products 82**
 - Decorative pipes 82
 - Ribbed bends 82
 - Dolphin bends 82
 - Gargoyles 82
 - Semi-circular facade hopper heads 83
 - Semi-circular corner hopper heads 83
 - Ornamented hopper heads 84
 - Zinc steps 84
 - Stamped gutters 85

Tradition and Service

The heirs of an art

The Haussman and Universal Exhibition works in the 19th century left us an extraordinary architectural heritage.



The ancient Greeks and Romans already decorated the tile roofs of their houses with terracotta designs. It was in the 12th and 13th centuries that metal roof finishes, which were more sophisticated due to the increased roof pitches, saw their functions extended to become a support for decorations and become part of roof embellishments. Finials, ridges and gutters were used to identify the owners of essentially feudal or religious buildings.

It was only in the 19th century that metal decorations became widespread on all types of building. With the introduction of rolled zinc on roofs and the improvements in the uses of stamped zinc by the Grados establishments, the tradesmen of the period had access to a new means of artistic expression.

Ridges and gutter fronts took on relief, cover strips were decorated with gadroons, ovals and rings, awnings became sculptures. Gradually, metal replaced the use of stone on roofs. The accomplished feats gave metal ornamentation its titles to nobility as well as an incredible expansion.

Tradition and Service

The heirs of an art



For over a century and a half Les Ateliers d'Art Français have been manufacturing zinc and copper roof ornaments. This prestigious product line is now marketed under the VMZINC® brand.

In the first section, you will also find a short line of roof ornaments that are excellent value for money thanks to the combined expertise of VMZINC® in roofing products and the know-how of our ornamental metal workers.

The vocation of VMZINC® is to perpetuate the roof ornament tradition and to pass a unique art form on to future generations of which the Ateliers d'Art Français are currently the reference. Over the years, we have collected old catalogues, architect's drawings and stamping dies so that we can produce historic parts identically and thereby work to preserve our heritage.

Each project is a new challenge. Ornamental metal workers try and try again, spend the time needed to find or rediscover an old decoration, define its exact shape, finely remodel it and adapt it to changes in supports and framework.

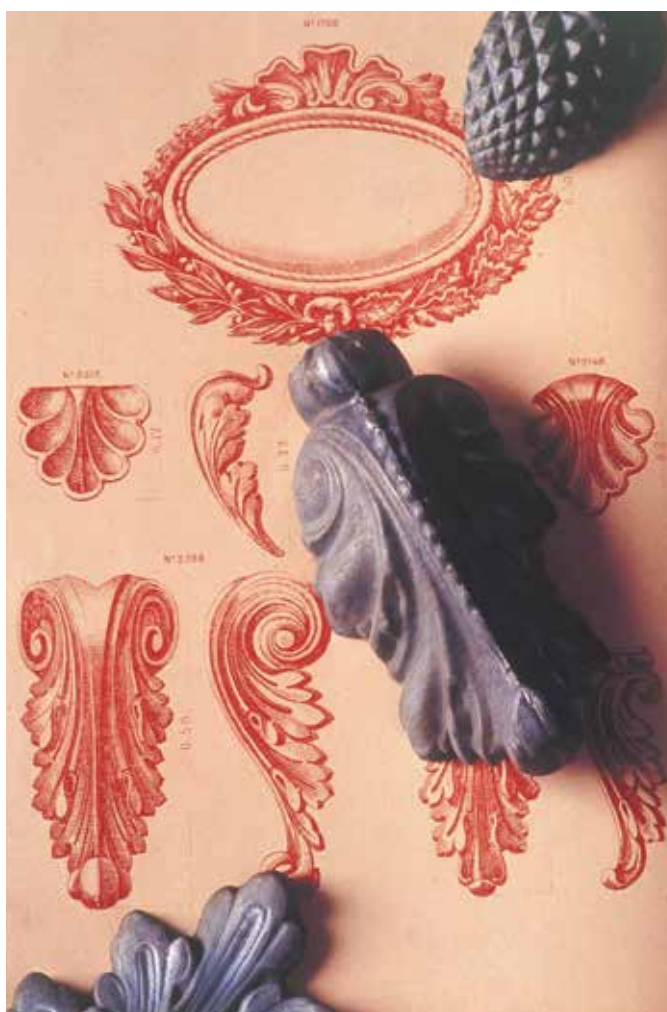

Tradition and Service

Unique know-how

More than just a trade, metal ornamentation is know-how that has been passed down directly from experienced ornamental metal workers to apprentices for over a century and a half. In the pure tradition of artistic trades, it is in contact with experienced ornamental metal workers alongside everyday experience, that apprentices will one day inherit secular tradition.

Five to seven years are needed to master sheet metal work to be able to create complex decorative parts. In addition to precision shaping and welding-brasing, skills from additional trades such as boiler-work, stamping and foundry work need to be learnt. Their unique know-how are at the service of the renovation of roofs decorated with dormer windows, bull's eyes, campaniles, domes, finials, which are all the signs of a triumphant 19th century.

Identical reproduction of old decorations from original models

Even though exclusively hand-made, all the ornaments produced by VMZINC® are drawn to a scale of 1 before being reproduced. This preparatory work makes it possible to guarantee the greatest respect for detail, increased assembly precision and perfectly regular series.



Tradition and Service

Unique know-how

Creation of long gone decorations using engravings, photographs or detailed sketches.

Ornamental metal workers may alter or even recreate certain missing parts of an ornament destroyed by time, using contemporary documents as inspiration.

A market reference

Their perfect mastery of all the production phases makes it possible for our ornamental metal workers to offer high levels of finishing, very regular assemblies and very fine details in stamped decorations. The quality of work provided by our workshops is a reference for all professionals working on roof renovation projects with ornaments.

Publishing old decorations

VMZINC® by Ateliers d'Art Français proposes a range of 300 standard references, some of which have existed for more than a century, grouped into six main families:

- Dormer windows and bull's eyes
- Finials, pinnacles, and flames
- Weathervanes and compositions
- Smooth and stamped profiles
- Stamped designs
- Stamped shingle panels and ornamented rainwater down pipes.

The entire range is available in rolled zinc and copper.

The quality of service of a major brand

VMZINC® is an international brand recognised for its rolled zinc products.

The advice, technical support and on site support provided by VMZINC® are the guarantee of a very high quality of service.



3D scan on site by our design office. Contact us for further information.

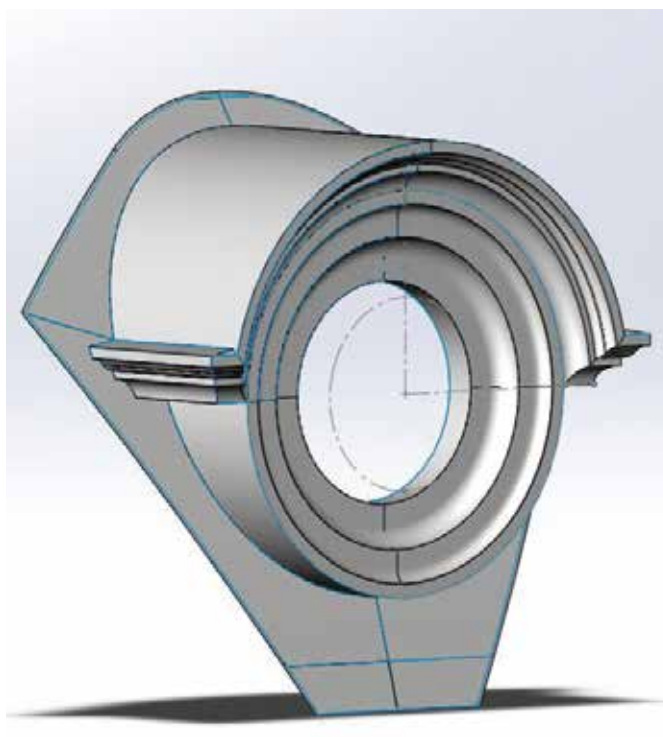

Finials, fire urns pinnacles and flames

Finials are ornaments placed on the roof ridge, at the meeting of the hip rafters, on the framework king posts. If their main function is to protect the framework from rainwater infiltrations, finials quickly became roof decoration elements, extending the lines of the roof with a vertical and elegant projection. Square, circular, short and stout or elevated and extended, finials adapt to different roof shapes. Topped by a pineapple-shaped decoration, they can also be used as a pinnacle. Finials can be used alone or as bases for weathervanes. Flame finials are classic architectural ornaments that were originally in stone in the form of a vase with a flame.



> Finials, pinnacles and flames	10
> Traditional finials	14
> Standard finials, pinnacles and flames	18
Square finials	18
Pinnacle finials	18
> Finials	19
Modified bases	19
Bespoke bases	19
Fixing rods	19

Finials, fire urns, pinnacles and flames

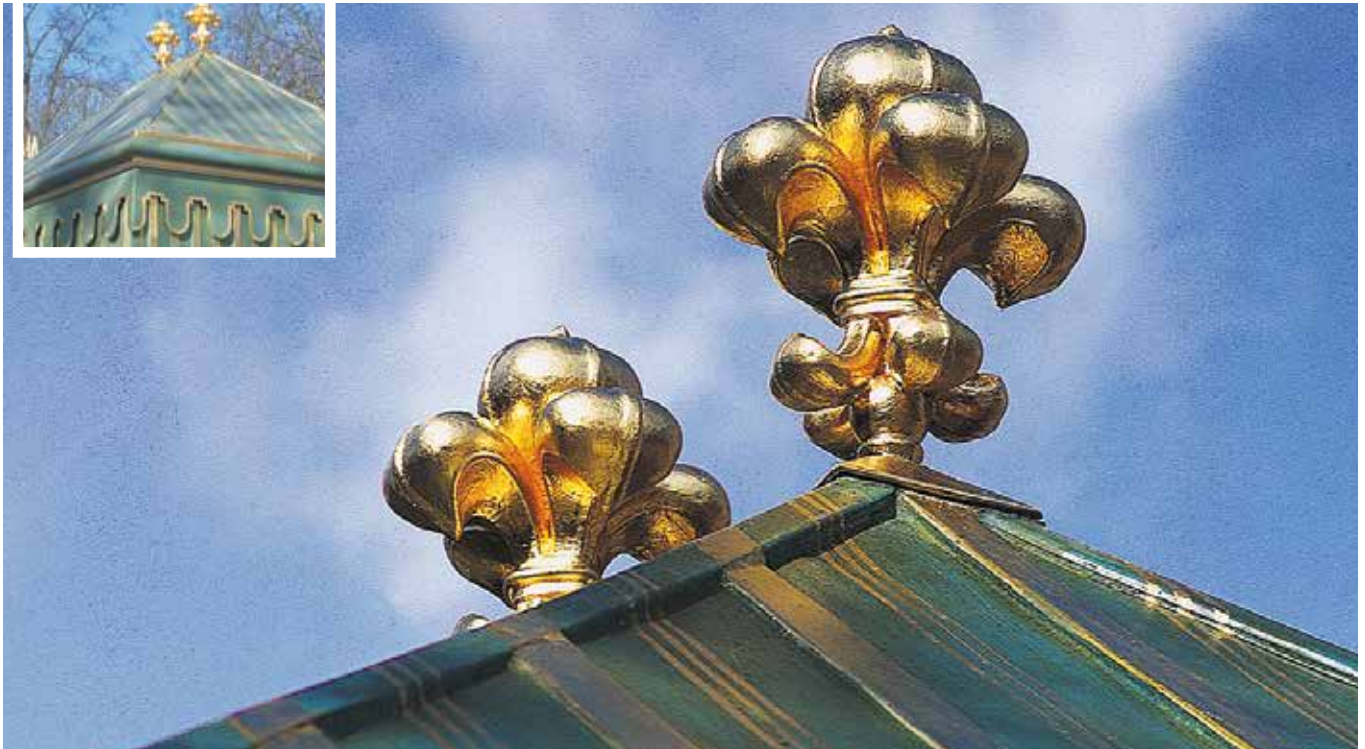

Château de Versailles (France)*



Paris (France)*

* Bespoke model

Finials, fire urns, pinnacles and flames



*Institut Notre Dame, Cerexhe Heuseux (Belgium)**



*Château de Madrid, Neuilly-sur-Seine (France)**



*Musée d'Orsay, Paris (France)**

* Bespoke model

Finials, fire urns, pinnacles and flames



*Pinnacle finial**



*Château de Monte-Christo, Marly-le-Roi (France)**

* Bespoke model

Finials, fire urns, pinnacles and flames



*Bank, Nantes (France)**



*Town hall, Corbeil- Essonnes (France)**

* Bespoke model

Traditional finials



Traditional finials

Designation	Height (cm)	Base		Indicative gable height (m)	Aspects
		Width (mm)	Height (mm)		
Traditional finial 101	30	141	140	3 to 4	 Natural zinc Copper
Traditional finial 101	40	141	140	3 to 4	
Traditional finial 101	50	175	190	4 to 6	
Traditional finial 101	65	175	190	4 to 8	
Traditional finial 101	80	195	220	5 to 9	
Traditional finial 101	100	195	220	6 to 10	
Traditional finial 102	50	141	140	4 to 6	
Traditional finial 102	70	175	190	5 to 9	
Traditional finial 103	55	141	140	4 to 6	
Traditional finial 103	75	175	190	5 to 9	
Traditional finial 103	90	195	220	5 to 9	
Traditional finial 104	50	141	140	4 to 6	
Traditional finial 104	65	175	190	4 to 8	
Traditional finial 104	75	175	190	5 to 9	
Traditional finial 104	95	195	220	6 to 9	
Traditional finial 105	38	∅ 175	190	3 to 4	
Traditional finial 105	45	∅ 175	190	3 to 4	
Traditional finial 105	52	∅ 175	190	4 to 6	
Traditional finial 105	61	∅ 200	236	4 to 6	

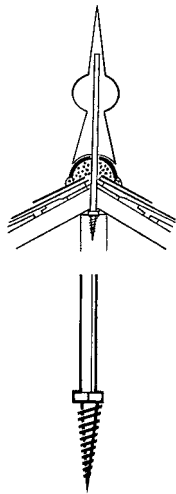

Steel long screw

All finials are delivered with a long screw.

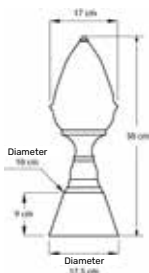

Pineapple

Reference	Height (cm)	Diameter (cm)	Aspects
Pineapple 106	50	17,5	 Natural zinc Copper
Pineapple 3601			



Standard finials

All our finials are available in natural zinc and copper.

All finials of a height up to 1.20 m are delivered with a long screw ref 4503.



3412

Reference	Height (cm)	Base in mm			Rod diameter (mm)	Diameter of the sphere or largest repoussé-work (mm)	Finial for weather vane	Indicative gable height (m)	Aspects
		Basis	Height	Top					
3412	90	140 x 140	200	Ø 80	16	Ø 150	■	5 to 9	■ Natural zinc ■ Copper
	180	200 x 200	380	Ø 140	18	Ø 240	■ ■	12 to 18	
3463	45	110 x 110	130	Ø 70	16	Ø 102		3 to 4	
	60	125 x 125	155	Ø 70	16	Ø 106		4 to 6	
	90	140 x 140	205	Ø 85	16	Ø 121	■	5 to 9	
3701	120	160 x 160	255	Ø 100	18	Ø 137	■	10 to 15	
	100	125 x 125	180	Ø 72	18	Ø 127	■	6 to 10	
	150	175 x 175	260	Ø 100	18	Ø 172	■ ■	12 to 15	
4015	190	240 x 240	350	Ø 138	30	Ø 252	■ ■	15 to 20	
	100	123 x 123	314	123 x 123	16	Ø 133		6 to 10	
4060	160	184 x 184	470	184 x 184	18	Ø 200	■ ■	12 to 15	
	30	60 x 60	100	Ø 40	-	80		3 to 4	
	40	75 x 75	135	Ø 50	-	100		3 to 4	
	50	105 x 105	165	Ø 60	16	130		4 to 6	
	60	135 x 135	192	Ø 80	16	150		4 to 6	
4062	80	160 x 160	245	Ø 112	16	220		5 to 9	
	100	200 x 200	315	Ø 147	18	300		6 to 10	
	50	100 x 100	110	Ø 52	16	80 and 100		4 to 6	
	70	130 x 130	145	Ø 71	16	90 and 145		5 to 9	
4063	90	160 x 160	190	Ø 80	16	130 and 190		5 to 9	
	45	85 x 85	120	Ø 51	16	Ø 102		3 to 4	
	70	125 x 125	175	Ø 81	16	Ø 140		5 to 9	
	90	140 x 140	240	Ø 81	16	Ø 172	■	5 to 9	
	120	160 x 160	250	Ø 81	18	Ø 172	■	10 to 15	

■ Finial for weathervane ■ Finial for weathercock

For finials to be properly fixed, it is essential to install them on a fixing rod:

- Finials up to a height of ≤ 1.20 m, long screw delivered with the finial
- Finials of a height > 1.20 m, plan for a fixing rod suitable for the support.

Standard finials



3463



3701



4060



4063



4015



4062

Standard finials



4067



4064

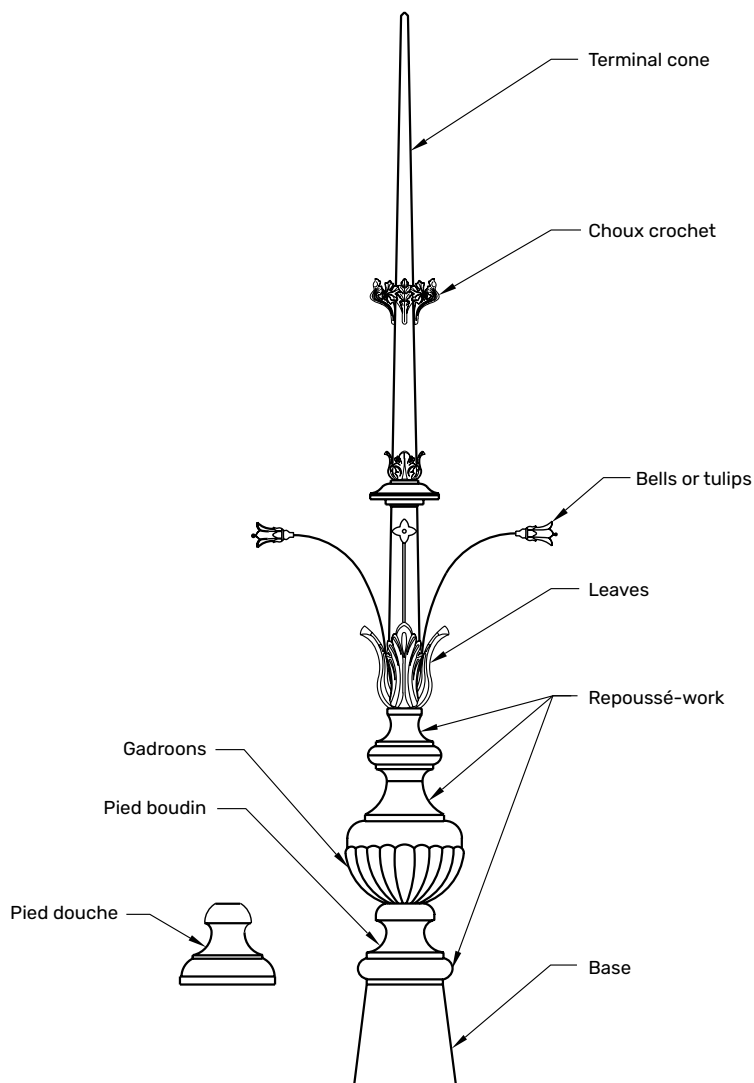

Finial glossary

Reference	Height (cm)	Base (mm)			Rod diameter (mm)	Sphere diameter of the largest repoussé-work (mm)	Finial for weather vane	Indicative gable height (m)	Aspects
		Basis	Height	Top					
4064	120	135 x 135	190	Ø 85	18	Ø 140	■	10 to 15	■ Natural zinc ■ Copper
	145	165 x 165	250	Ø 90	18	Ø 187	■ ■	12 to 15	
	175	200 x 200	300	Ø 120	18	Ø 235	■ ■	12 to 18	
4067	100	135 x 135	185	Ø 80	18	160	■	6 to 10	
	120	160 x 160	245	Ø 112	18	220	■	10 to 15	
	150	200 x 200	300	Ø 147	18	300	■ ■	12 to 15	

■ Finial for weathervane ■ Finial for stamped cockerel

Standard finials, pinnacles and flames

Square finials

All square finials are assembled with a fixing rod.



3481



4115

Ref.	Height (cm)	Base (mm)			Dimension of the biggest shape (mm)	Indicative gable height (m)	Aspects
		Base	Height	Top			
3481	80	125 x 125	210	79 x 79	160 x 160	5 to 9	<ul style="list-style-type: none"> Natural zinc Copper QUARTZ-ZINC® ANTHRA-ZINC® AZENGAR®
	100	150 x 150	260	100 x 100	200 x 200	6 to 10	
	125	190 x 190	320	124 x 124	250 x 250	10 to 15	
	150	213 x 213	128	150 x 150	300 x 300	12 to 15	
4115	65	220 x 220	254	130 x 130	240 x 240	4 to 6	

Pinnacle finials

All pinnacle finials are delivered with a long screw ref 4503.

For finials to be properly fixed, it is essential to install them on a fixing rod:

- Finials up to a height of ≤ 1.20 m, long screw delivered with the finial
- Finials of a height > 1.20 m, plan for a fixing rod suitable for the support.



3601



4146

Reference	Height (cm)	Base (mm)		Aspects
		Basis	Height	
3601	30	120 x 120	50	<ul style="list-style-type: none"> Natural zinc Copper
	40	150 x 150	50	
4146	60	200 x 200	80	

Finials

Modified bases

All standard finials can be manufactured with a special base. Please provide base dimensions in mm.Ø

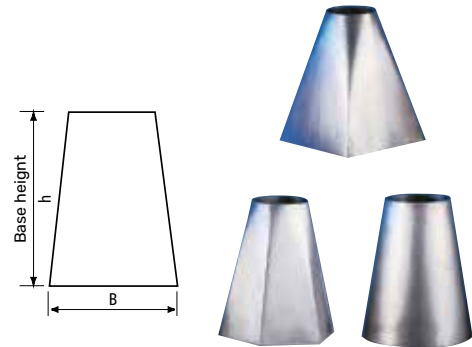

Bespoke bases

Bespoke bases can also be manufactured (contact us).



Fixation rods

Base rod assembly

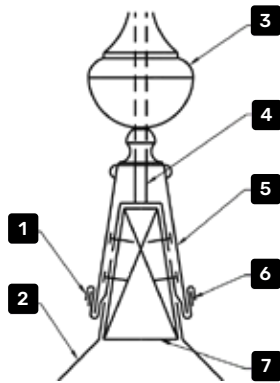

Long screw assembly

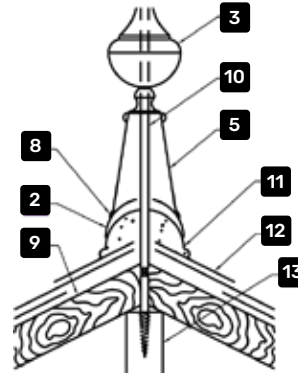

Base rod

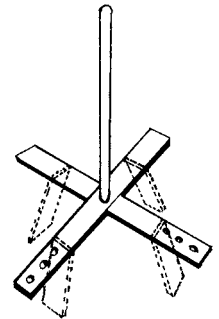

4501

- 1 Catch hook
- 2 Weather proofing
- 3 Finial
- 4 Base rod
- 5 Base
- 6 Hasp
- 7 Punch
- 8 Weld
- 9 Rafter
- 10 Long screw
- 11 Ridge
- 12 Roof
- 13 Ridge purlin

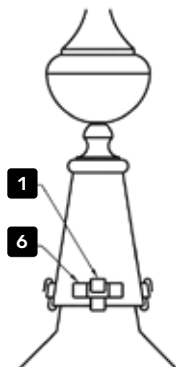

Ref.	Height (cm)	Diameter (mm)
4501	50	16
	100	16
	120	18
	150	18
	175	18
4503	200	30
	50	16
	100	16

Long screw



4503

Weather vanes and compositions

In feudal times, weather vanes were a distinctive sign of nobility, a feudal mark that was a substitute for a banner. It was in the 18th century that their use became widespread and decorative. At the time their design and outline personified their owner's trade or passions.

Placed on a finial at the top of a roof, weather vanes indicate the wind direction. Cut-out in shape (outline) or stamped (in volume) such as cockerels that are seen at the tops of church steeples, weather vanes can be combined with a finial and the cardinal points to create a composition. Weather vanes are part of our heritage and spin with the winds of history.



> Weather vanes and compositions	22
Compositions	24
Standard compositions	25
> Weather vanes	28
Standard stamped cockerels	29
Stamped cockerel assembly	30
Standard stamped weather vanes	31
Standard cut weather vanes	32
Standard arrows and flags	32
> Standard cardinal points	33

Weather vanes and compositions



House in Hurepoix (France)



Composition with cut-out weathervane



Composition with stamped weathervane

Weather vanes and compositions

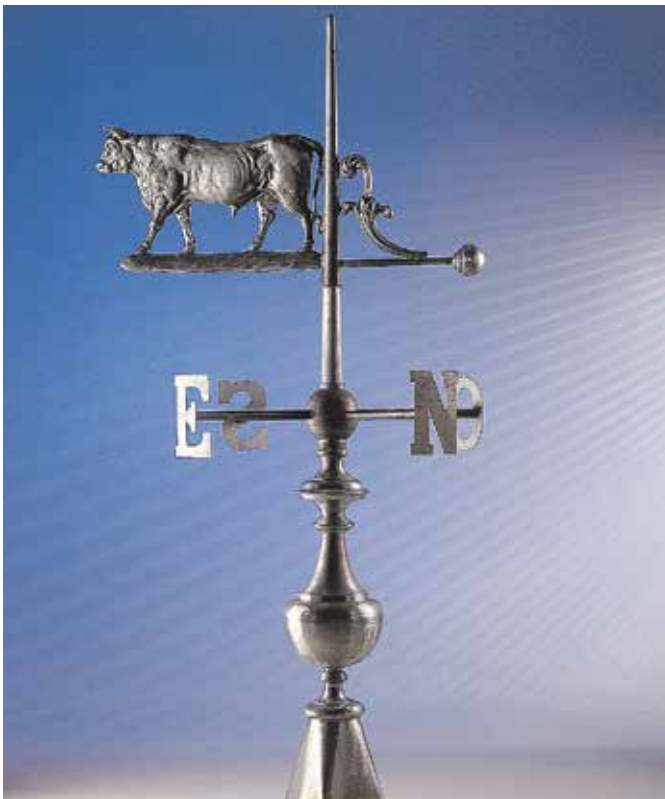

Composition with stamped cockerel



Town house, Cognac (France)



Composition with cut-out weathervane

Compositions

Traditional compositions



Composition with base finial 101



Composition with base finial 102



Composition with base finial 104

Traditional compositions sold in kit form (finial + weathervane + cardinal points + rod).
Please indicate the finial model and weathervane design with the order.



Weathervane designs



202 Roofer



203 Cockerel



204 Caravel



205 Horse



206 Hunter



207 Cat



208 Fisherman

Designation	Height (cm)	Aspects
Composition with base finial 101	80	 Natural zinc Copper
Composition with base finial 102	70	
Composition with base finial 104	75	

Cockerel 209 composition to assemble



Registered model

Designation	Ref. zinc		Height (cm)	Total span (cm)	Circular base diameter (cm)	Aspects
	Zinc	Copper				
Komposition Hahn 209	220017092	220017091	94	48	19,5	 Natural zinc Copper



Standard compositions

Guide for selection-compatibility

Composition glossary

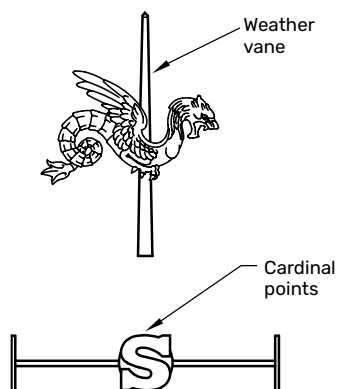

Gable	Finials	Cardinal points	Arrows	Cut-out weather vanes	Flags	Stamped weather vanes	Cockerels
Height (m)	Height (cm)	Span (cm)	Span (cm)	Span (cm)	Span (cm)	Span (cm)	Span (cm)
5 to 9	90	40 to 50	40		40		
6 to 10	100	50	40	< 55	40		
10 to 15	120	50	50	> 55	45	> 55	40 to 50
12 to 15	150	60	60	> 55	45	> 55	50 to 55
12 to 18	175	60	60	> 55	45	> 55	50 to 55
15 to 20	220	60		> 55		> 55	50 to 55
15 to 20	340	60		> 55		> 55	50 to 55

The table above can be used to select finials, cardinal points and weathervanes with coherent proportions.

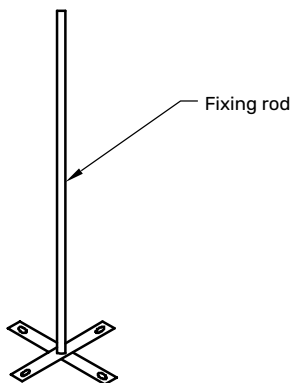
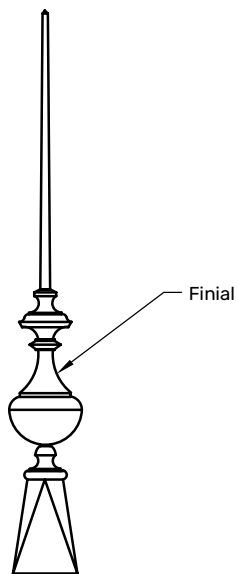

Standard compositions



3480

Reference 3480 composed of:

- Specific finial for this composition
- Specific cardinal points for this composition
- Chimera weathervane ref. **2211**.



4126

Reference 4126 composed of:

- Finial specific to this composition
- Cardinal points specific to this composition
- Chimera weathervane ref. **4161**.

Ref.	Height (cm)	Base (mm)			Rod diameter (mm)	Design span (cm)	Diameter of the sphere or largest repoussé-work (mm)	Indicative gable height (m)	Aspects
		Basis	Height	Top					
3480	240	diam 220	280	ø 148	30	55	ø 258	15 to 20	 Natural zinc Copper
4126	320	315 x 315	480	ø 168	30	55	ø 345	15 to 20	

Standard compositions

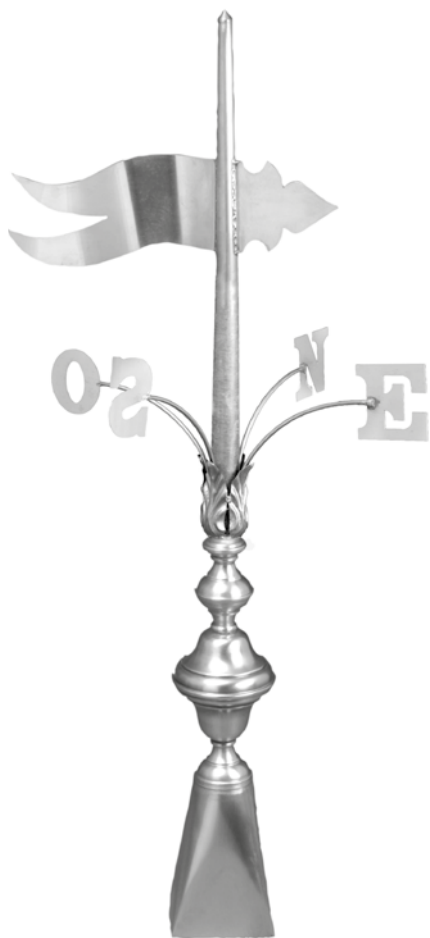

3440

Reference 3440 composed of:

- Finial ref. **3701**
- Cardinal points ref. **2970**
- Flag weathervane ref. **2950**.



4055

Reference 4055 composed of:

- Finial ref. **4064**
- Cardinal points ref. **2969**
- Flag weathervane ref. **2947**.

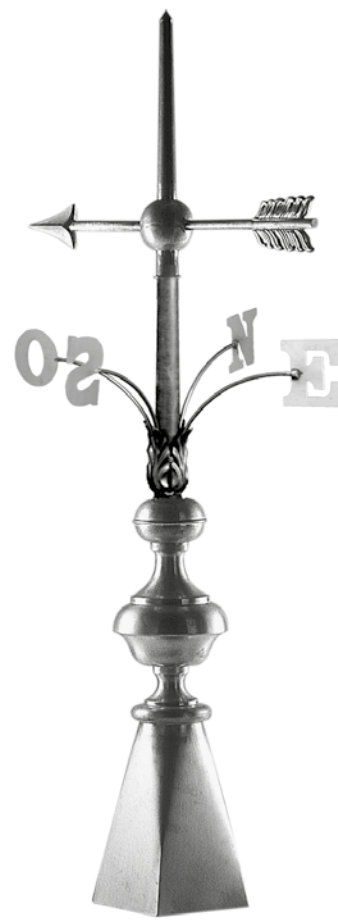

4090

Reference 4090 composed of:

- Finial ref. **4063**
- Cardinal points ref. **2970**
- Arrow weathervane ref. **2944**.

Ref.	Height (cm)	Base (mm)			Rod diameter (mm)	Design span (cm)	Diameter of the sphere or largest repoussé-work (mm)	Indicative gable height (m)	Aspects
		Basis	Height	Top					
3440	100	125 x 125	180	ø 72	18	40	ø 127	6 to 10	<div style="display: flex; align-items: center;"> <div style="width: 15px; height: 15px; background-color: #d3d3d3; margin-right: 5px;"></div> Natural zinc <div style="width: 15px; height: 15px; background-color: #c08040; margin-left: 10px; margin-right: 5px;"></div> Copper </div>
	150	175 x 175	260	ø 100	18	40	ø 172	12 to 15	
4055	155	245 x 245	280	ø 90	18	55	ø 187	12 to 15	
4090	120	160 x 160	250	ø 81	18	40	ø 172	10 to 15	

Weather vanes

The weather vanes are to be mounted on a 101, 102 or 104 finial from the VMZINC® line (height 70 cm or more).
Finials sold separately.

Stamped cockerel 301



Designation	Span (cm)
Stamped cockerel 301	42

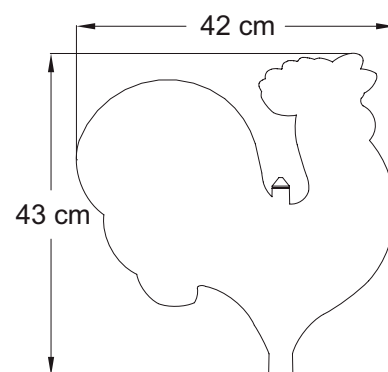

Stamped goose 302



Designation	Span (cm)
Stamped goose 302	60

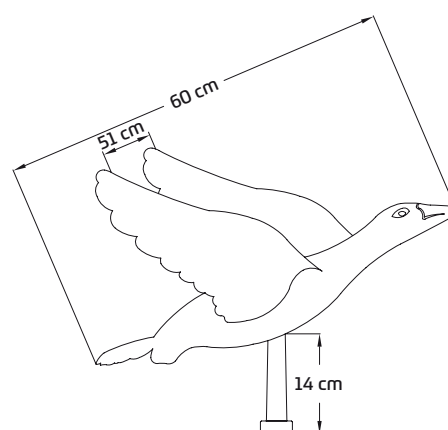

Stamped cockerel and goose: registered models

The weather vanes are delivered with cardinal points 902 (zinc or copper).

Weather vanes

Standard stamped cockerels

All our cockerel models can be mounted on all rod types.

All cockerels are delivered assembled. Indicate the diameter or taper.



2242



2333



2336

Reference	Span* (cm)	Sphere diam. (cm)	Assembly possible				Aspects
			Type A	Type B	Type C	Type D	
2242 Gothic cockerel	50	-	Yes	Yes	Yes	No	■ Natural zinc ■ Copper
2333 French cockerel feet and spheres	40	∅ 12	Yes	Yes	Yes	No	
	55	∅ 16	Yes	Yes	Yes	No	
	70	∅ 25	No	No	No	Yes	
2336 French cockerel	40	-	Yes	Yes	Yes	No	
	55	-	Yes	Yes	Yes	No	
	70	-	No	No	No	Yes	

* Other spans, contact us.

NOTE :

Stamped cockerels are only assembled on finials of a height ≥ 145 cm.

Weather vanes

Cockerel assembly - Type A

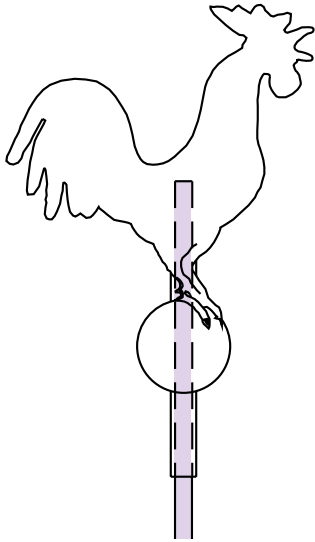

Assembly on non traversing sheath with glass bead.
Cockerel span < 70 cm assembled on rod.

Cockerel assembly - Type B

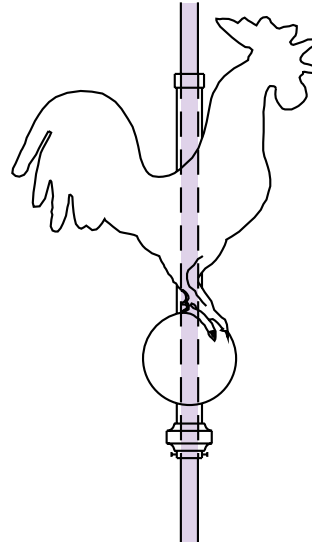

Assembly on traversing sheath with ball.
Cockerel span < 70 cm assembled on rod with or without lightning conductor.

Cockerel assembly - Type C

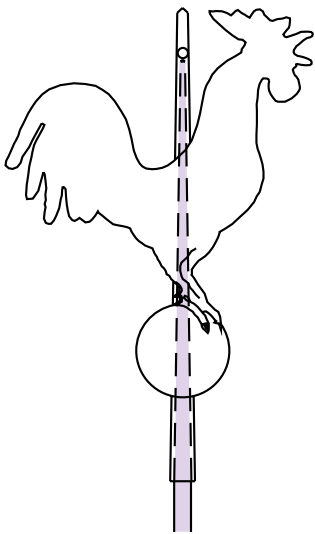

Assembly on traversing sheath with glass bead.
Cockerel span < 70 cm assembled on finial of a height \geq 145 cm.

Cockerel assembly - Type D

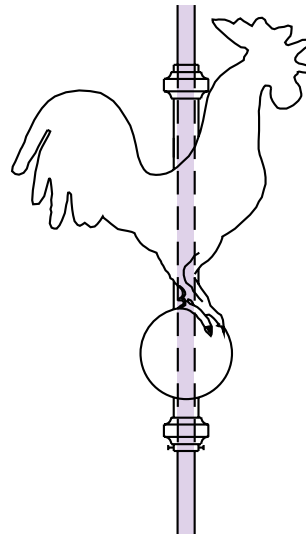

Assembly on traversing sheath with two balls.
Cockerel span \geq 70 cm assembled on rod with or without lightning conductor.

NOTE :

Stamped cockerels are only assembled on finials of a height \geq 145 cm

Standard stamped

Weathervanes

For this line of stamped weathervanes, the following models are available: chimera, pigeon, lion and horse. They are available in natural zinc and copper.



2211

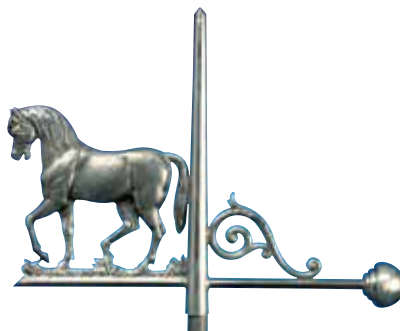

2609



2650



4159



4161

Reference	Span (cm)	Sphere diam. (mm)	Aspects
2211	55	-	<div style="display: flex; align-items: center;"> <div style="width: 10px; height: 10px; background-color: #d3d3d3; margin-right: 5px;"></div> Natural zinc <div style="width: 10px; height: 10px; background-color: #c08040; margin-right: 5px; margin-top: 5px;"></div> Copper </div>
2609	55	-	
2650	69	-	
4159	35	120	
4161	55	-	

For these weathervanes, plan for a finial at least 1.20 m high.

NOTE:

Pigeons are not accurate weather vanes.

Standard cut-out

Weathervanes



4169



2159



2151

Reference	Span (cm)	Aspects
2151	60	■ Natural zinc
2159	72	■ Copper
4169	58	■ Copper

Personalised designs tailor-made from a drawing or photograph according to estimate.
For these weathervanes, plan for a finial at least 1.20 m high.

Standard arrows and flags

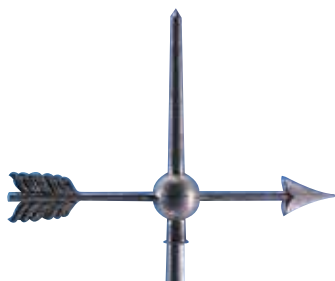

2944

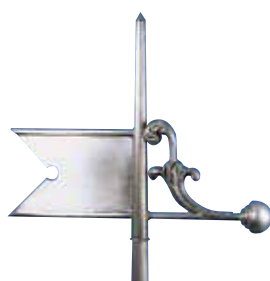

2947

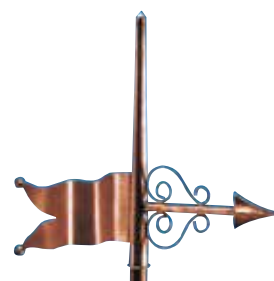

2948

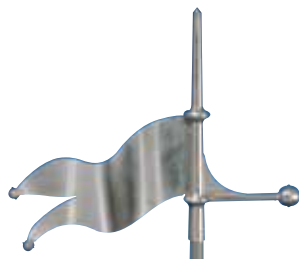

2949



2950

Ref.	Span (cm)	Aspects
2944	40 - 50 - 60	■ Natural zinc
2947	45	■ Copper

Ref.	Span (cm)	Aspects
2948	55	■ Natural zinc
2949	48	■ Copper
2950	40	■ Copper

Standard cardinal points



2969



2968

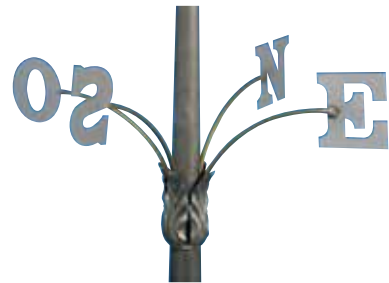

2970

Ref.	Span (cm)	Aspects
2968	50	 Natural zinc Copper
	60	
	70	
2969	55	
2970	40	
	50	

All letters can be produced on demand.
 For ref. 2969 cardinal points, plan for a finial at least 1.20 m high.

Domes, Campaniles, Arrows, Kiosks

Their majestic outlines are landmarks in our cities. The cladding of these structures is composed of successive superimposed decorations. The flagship know-how of our Ateliers d'Art Français trained ornamental metal workers, these productions require perfect mastery of all metal processing techniques and may require up to 3 different alloys for zinc decorations. Some structures, in particular creations, may require several months of studies before the first elements can begin to be produced.



Domes, Campaniles, Arrows, kiosks



Hotel, Cannes (France)



Theatre, Quimper (France)

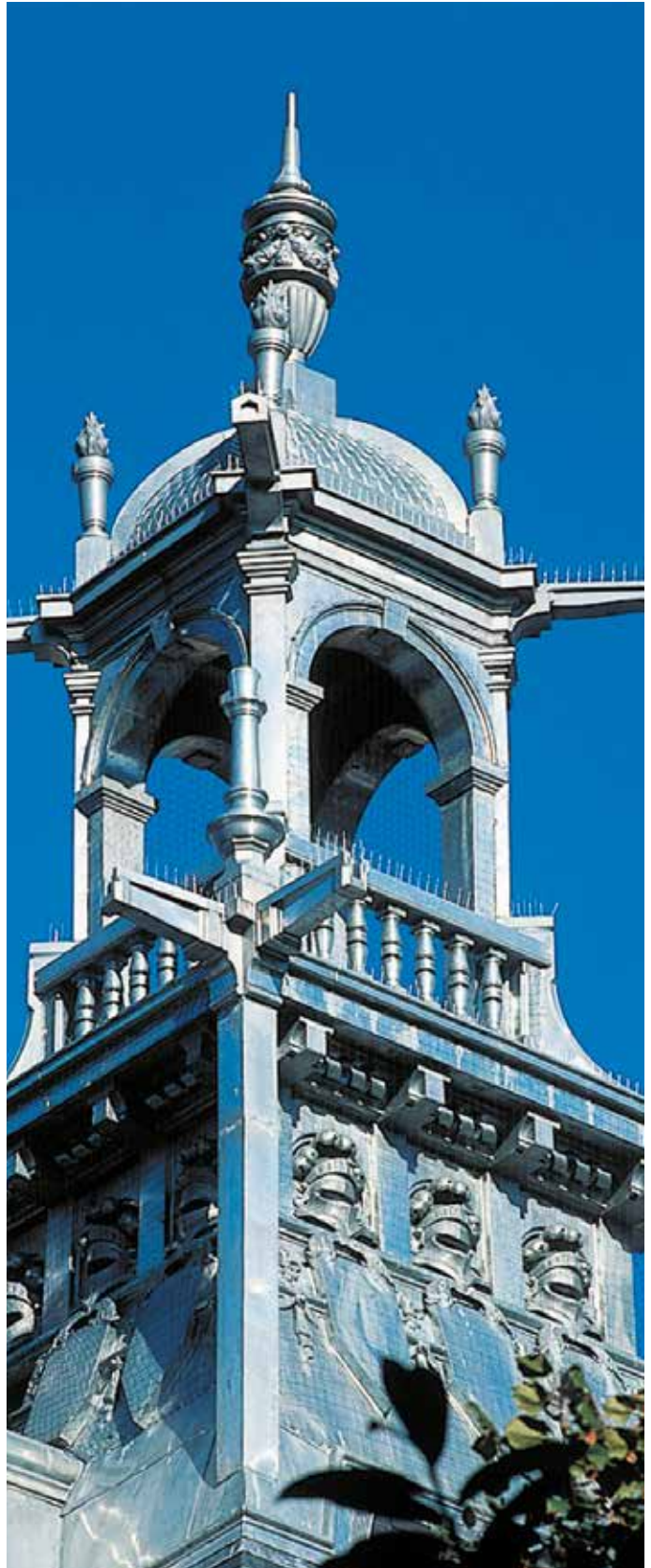

Château de Madrid, Neuilly-sur-Seine (France)

Domes, Campaniles, Arrows, kiosks



Town hall, Corbeil-Essonnes (France)



Town hall, Montluçon (France)



Avenue Montaigne, Paris (France)

Domes, Campaniles, Arrows, kiosks



Kiosk, London (UK)



Vitry-le-François (France)



Grand Palais, Paris (France)

Bull's eyes and dormer windows

They appeared in the 13th century to ventilate the attics of high roofs, it was not until the 19th century that the use of dormer windows and bull's eyes became widespread, especially in cities where attics were converted into housing. Bull's eyes and dormer windows come in various styles and shapes and embellish the majestic beauty of roofs of period residences and prestigious buildings. Thanks to their command of zinc and copper work, our ornamental metal workers can reproduce these ornaments in series.



- > **Bull's eyes and dormer windows** **40**
- > **Standard bull's eyes and dormer windows** **46**
 - Joinery 47
 - Elements required for a quote 48
- > **Standard dormer windows** **49**
 - Elements required for a quote 50
- > **Standard key accessories** **51**

Bull's eyes and dormer windows



*Boulevard Haussman, Paris (France)**



*Theatre, Quimper (France)**

* Bespoke model

Bull's eyes and dormer windows



*Town hall, Corbeil-en-Gatinais (France)**



*Annecy (France)**

* Bespoke model

Bull's eyes and dormer windows



*Court house, Montpellier (France)**



*Honfleur (France)**



*Department store, Paris (France)**

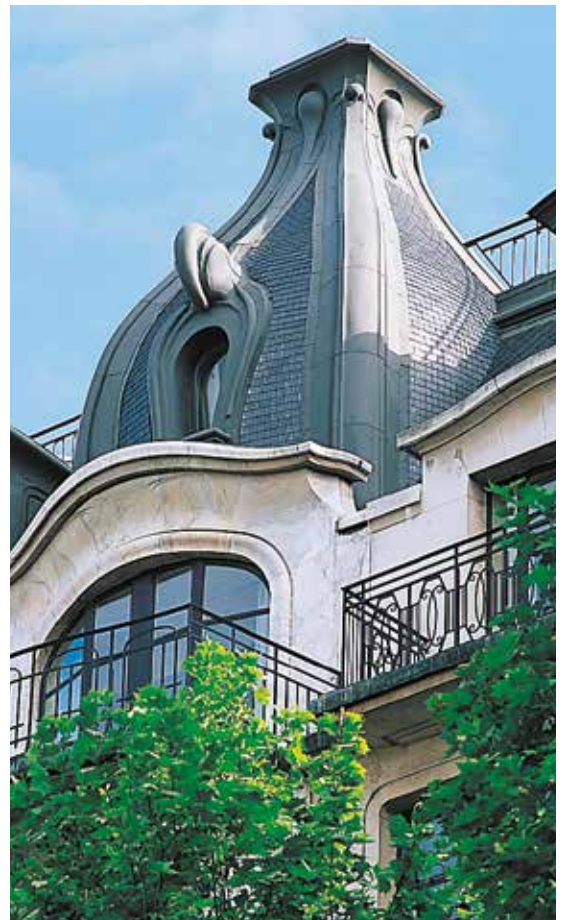

*Boulevard des Capucines, Paris (France)**

* Bespoke model

Bull's eyes and dormer windows



*Town hall, Corbeil-en-Gatinais (France)**



*Town hall, Corbeil-Essonnes (France)**

* Bespoke model

Bull's eyes and dormer windows



*Copper dormer windows, Belgium**



*Avenue du Président Wilson, Paris (France)**

* Bespoke model

Bull's eyes and dormer windows



*Vuaz-en-Sallaz (France)**



*Avenue Georges Mandel, Paris (France)**



*Rue de Téhéran, Paris (France)**

* Bespoke model

Standard bull's eyes

All our standard bull's eye windows are supplied for facades or with slopes and flanges. This range is available in defined dimensions and styles in Natural zinc, QUARTZ-ZINC®, ANTHRA-ZINC® and copper. The models presented are intended for new buildings. Use in renovations may require modifications to the building structure (contact us).

Ref.	Opening in m	Total dimensions in m		Assembled key	Existing joinery p.24	Aspects
		Height	Width			
3020 and 3021*	0,60 x 0,40	0,97	0,95	2281/028		<ul style="list-style-type: none"> Natural zinc Copper QUARTZ-ZINC® ANTHRA-ZINC®
	0,65 x 0,50	1,04	1,06	2282/040		
	0,70 x 0,50	1,13	1,16			
	0,80 x 0,60	1,29	1,31			
	0,90 x 0,60	1,40	1,31			
3022	0,60 x 0,40	0,96	1,00	-		<ul style="list-style-type: none">
	0,65 x 0,50	1,03	1,12	-		
	0,70 x 0,50	1,08	1,12	-		
	0,80 x 0,60	1,21	1,27	-		
	0,90 x 0,60	1,31	1,27	-		
3023	diam. 0,75	1,23	1,27	-		
3024 and 3025*	0,50 x 0,40	0,95	0,78	0605/032		<ul style="list-style-type: none">
	0,65 x 0,50	1,18	1,00			
	0,70 x 0,50	1,23	1,00			
	0,80 x 0,60	1,38	1,10	2282/040		
	0,90 x 0,60	1,48	1,16			
3026	diam. 0,75	1,18	1,28	-		
3065	diam. 0,25	0,46	0,46	-		<ul style="list-style-type: none">
3066	diam. 0,35	0,86	0,86	-		<ul style="list-style-type: none">
	diam. 0,40	0,98	0,98	-		
	diam. 0,45	1,02	1,02	-		
	diam. 0,50	1,07	1,07	-		
	diam. 0,60	1,23	1,23	-		
	diam. 0,65	1,32	1,32	-		
diam. 0,75	1,43	1,43	-			
3067	0,65 x 0,50	1,20	1,10	-		<ul style="list-style-type: none">
	0,70 x 0,55	1,20	1,10	-		
	0,80 x 0,60	1,35	1,23	-		
	0,90 x 0,60	1,47	1,23	-		
3070	0,50 x 0,40	6,95	9,50	-		<ul style="list-style-type: none">
	0,65 x 0,50	1,17	1,10	-		
	0,70 x 0,50	1,24	1,15	-		
	0,80 x 0,60	1,41	1,30	-		
	0,90 x 0,60	1,51	1,35	-		
4205	diam. 0,25	0,49	0,54	-		<ul style="list-style-type: none">
	diam. 0,28	0,53	0,58	-		
	diam. 0,32	0,57	0,62	-		
	diam. 0,38	0,69	0,74	-		
	diam. 0,60	1,07	1,16	-		
4206	0,45 x 0,32	0,74	0,72	-		<ul style="list-style-type: none">
	0,65 x 0,50	1,07	1,11	-		
	0,70 x 0,50	1,12	1,11	-		
	0,80 x 0,60	1,32	1,20	-		
	0,90 x 0,60	1,40	1,32	-		

*: identical to previous model without frontal key

Joinery

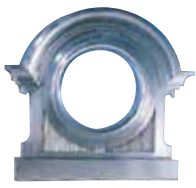

4211



7010

4211	diam. 0,50	1,08	1,16	-	■	■ ■ ■ ■
	diam. 0,60	1,30	1,39	-	■	
	diam. 0,75	1,52	1,65	-	■	
	diam. 0,90	1,94	2,08	-	■	
7010	diam. 0,50	9,15	9,25	-	■	■ ■

Joinery in red exotic wood, with casement, 24 mm double glazing (4/16/4), thickness 46 mm:

- with watertight seal installed on the window for inwards opening,
- with double watertight seal for swivel opening.

Option: fixed and small wooden frames for 4 panes.

Dimensions (cm)	
Reveal	Overall
Diameter 50	diam. 58
Diameter 60	diam. 68
Diameter 90	diam. 98
65 x 50	73 x 58
80 x 60	88 x 68
90 x 60	98 x 68



NOTE:

The joinery is designed to be fixed on the framework supporting the bulls eye window, and not inside (see drawing below).

Joinery installation

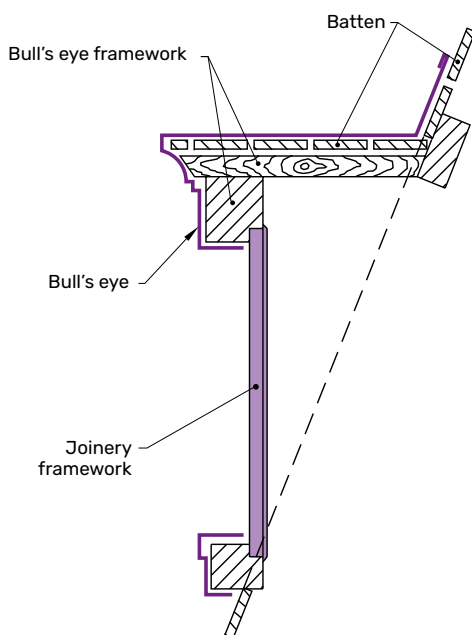

The total window size is always larger than the opening.

Fitting a bull's eye



Installing the wood structure*



Installing the bull's eye on the wood structure



Tile, slate or zinc finish

* The wood structure is not included in the ornament price.

ORNAMENTS

Request for a bull's eye quote

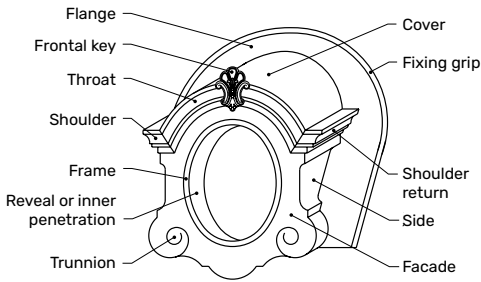

Project information

Site reference:

Company name:

Company phone number:

Return of the requested model with the order

Bull's eye information

Quantity:

Metal:

- Natural zinc QUARTZ-ZINC®
 ANTHRA-ZINC® Natural copper

- Catalogue bull's eye
 (indicate the ref.):
 Reproduction of the model

Pitch:

- On straight pitch (indicate measurement A):
 On curved roof
 On dome
 Facade only

Roof materials:

- Slate
 Metal
 Tile
 Other (indicate):

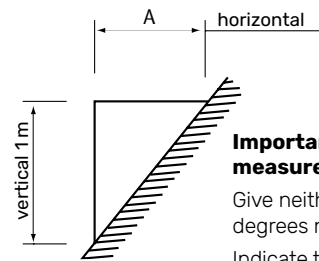

Important: measurement A

Give neither the pitch degrees nor percentage. Indicate the horizontal depth of A for a height of 1 metre. Example: depth of 40 cm for 1 m vertical.

Dealer stamp



Contact:
Phone:

Phone: 33 1 49 72 41 62 / 33 6 80 11 24 24
 Fax: 33 1 49 72 42 97
 email: vmzinc.ornaments@vmzinc.com

It is imperative to attach good quality photos showing as much detail as possible to your request.

Dimensions to provide (mm)

- Cover depth (B) :
 Opening width (C) :
 Opening height (D) :
 Total width (E) :
 Total height (F) :
 Roof pitch in ° :

Front view

length in the cover axis

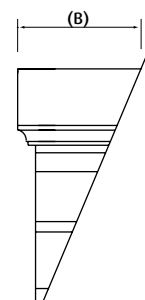

Profile view

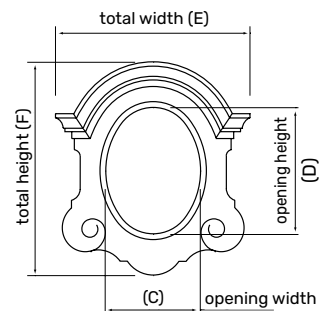

Standard dormer windows

All our referenced dormer windows are supplied for facades or with slopes and flanges. This range is available in defined dimensions and styles in Natural zinc, QUARTZ-ZINC®, ANTHRA-ZINC® and copper. The models presented are intended for new buildings.

Use in renovations may require modifications to the building structure (contact us).



Reference	Opening (m)	Total dimensions (m)		Mounted key	Aspects
		Height	Width		
3005	1,40 x 0,80	2,03	1,47	-	■ ■ ■ ■
	1,60 x 0,95	2,34	1,71	-	
3011	0,90 x 0,55	1,50	1,22	-	■ ■ ■
	0,90 x 0,70	1,50	1,37	-	
	1,20 x 0,80	1,88	1,58	-	
3012	0,90 x 0,55	1,36	1,17	-	■ ■ ■
3015	0,90 x 0,60	1,46	1,08	-	■ ■ ■ ■ ■
	1,00 x 0,75	1,68	1,38	-	
	1,20 x 0,95	2,00	1,68	-	
	1,40 x 1,15	2,24	1,88	-	
3460	1,00 x 0,60	1,34	1,08	-	■ ■ ■ ■ ■
3494	1,00 x 0,60	1,69	1,22	sphere Ø 160 mm	■ ■ ■
	1,30 x 0,75	2,09	1,48	sphere Ø 160 mm	
4203	0,75 x 0,46	1,12	1,04	4411 / 029	■ ■ ■ ■
	0,90 x 0,55	1,33	1,16	2282 / 040	
4204	0,75 x 0,46	1,06	1,04	-	■ ■ ■ ■ ■
	0,90 x 0,55	1,27	1,17	-	

ORNAMENTS

Request for a dormer window quote

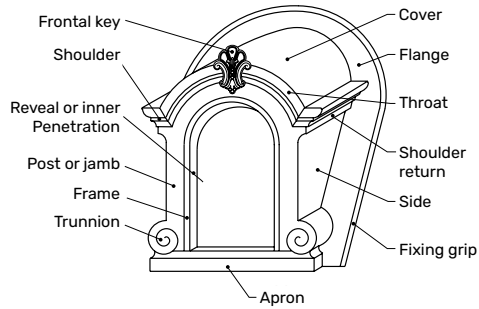

Project information

Site reference:

Company name:

Company phone number:

Return of the requested model with the order

Dormer window information

Quantity:

Metal:

- Natural zinc
- ANTHRA-ZINC®
- QUARTZ-ZINC®
- Natural copper

- Catalogue dormer window
(indicate the ref.):
- Reproduction of the model

Pitch:

- On straight pitch (indicate measurement cote A):
- On curved roof
- On dome
- Facade only

Roof materials:

- Slate
- Metal
- Tile
- Other (indicate):

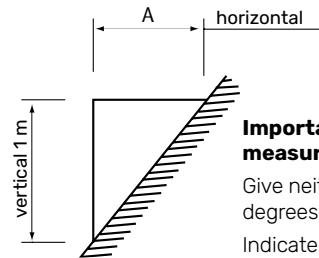

Important: measurement A

Give neither the pitch degrees nor percentage. Indicate the horizontal depth of A for a height of 1 metre. Example: depth of 40 cm for 1 m vertical.

Dealer stamp



Contact:

Phone:

Phone: 33 1 49 72 41 62 / 33 6 80 11 24 24
 Fax: 33 1 49 72 42 97
 email: vmzinc.ornements@vmzinc.com

Dimensions to provide (mm)

- Cover depth (B):
- Opening width (C):
- Opening height (D):
- Total width (E):
- Total height (F):

Front view

length in the cover axis (B)

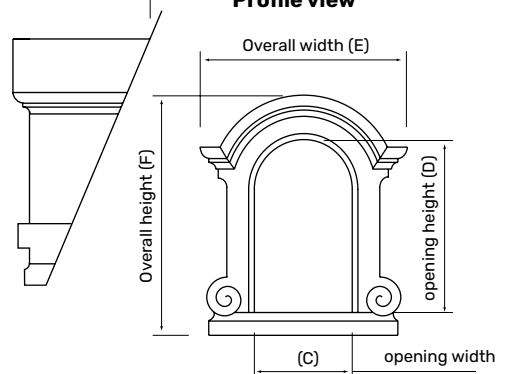

It is imperative to attach good quality photos showing as much detail as possible to your request.

Bull's eyes and dormer windows

Standard key accessories

All our key models are only sold with the bull's eyes and dormer windows they are intended for. The keys are available in natural zinc and copper. They can be manufactured to measure from an original model as part of the total reproduction of the ornament (contact us).



0605



0630



2281



2282



2283



2289



4396



4399



4401



4411

Key Ref.	Total height (cm)	Total width (cm)
0605	32	27
0630	20	18
2281	28	26,5
2282	40	31
2283	50	35,5
2289	40	36
4396	47	35
4399	43	39
4401	44	35
4411	29	21,5

Smooth and stamped profiles

Initially designed to waterproof the meeting of two roof slopes or an intersection, over time ornamental profiles have kept this essential function. Whether cover strips, angle rafter casings or the fronts of gutters, they can be produced "straight" and enhanced with rings or stamped with designs usually in the form of ovals or gadroons. Decorated with escutcheons, leafage or twists, they embellish the entire building, roof and facade, to full advantage.



> Smooth and stamped profiles	54
> Straight smooth profiles	56
Standard cover strips	56
Standard gutter fronts	57
Standard hand rails	58
> Curved smooth profiles	59
> Standard stamped profiles	60
Cover strips	60
Gutter fronts - Escutcheons	60

Smooth and stamped profiles



Stamped cover strip



*Curved gutter**



*Rue du 4 septembre, Paris (France)**



*Cover strip and rings, Versailles (France)**

* Bespoke model

Smooth and stamped profiles



*Grand Palais, Paris (France)**



*Grand Palais, Paris (France)**

* Bespoke model

Straight smooth profiles

Standard cover strips

Aspects available for all straight, smooth profiles:

- Natural zinc
- Copper
- QUARTZ-ZINC®
- ANTHRA-ZINC®
- AZENGAR®
- PIGMENTO® green
- PIGMENTO® red
- PIGMENTO® blue
- PIGMENTO® brown

1235

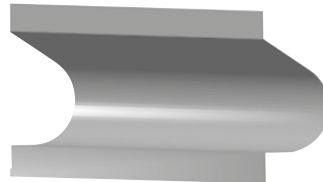

Standard formats (mm)

250	333
400	500
600	650



1236



Standard formats (mm)

250	333
400	500
600	650



Rings



1237

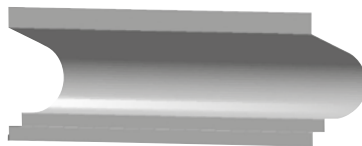

Standard formats (mm)

333	400
500	600
650	



1238



Standard formats (mm)

333	400
500	650

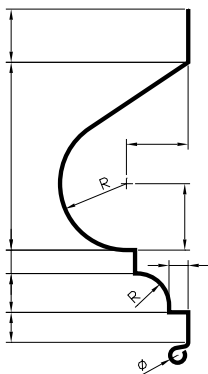

The standard cover strips are available in the formats given above. For cover strips with another format or made to model, indicate:

- The type or appearance of the metal,
- The thickness,
- The format,
- The length,
- With or without ring,
- With or without relief.

For the quote or production, a ring model, a template or a sketch featuring measurements is needed.

Straight smooth profiles

Standard gutter fronts



1231



Standard formats (mm)
333 400
500

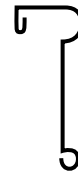

Clip and seam

1232



Standard formats (mm)
333 400
500



Rings

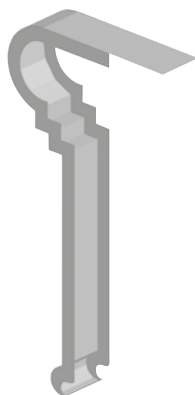

1233

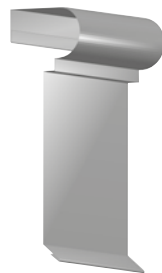

Standard formats (mm)
333 400
500



1234

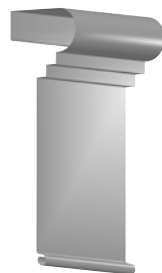

Standard formats (mm)
400 500
650

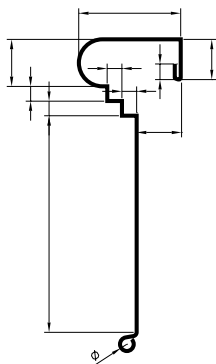
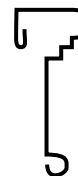

The standard gutter fronts are available in the formats given above. For curb gutter fronts of another format or made to model, indicate:

- The type or appearance of the metal,
- The thickness,
- The format,
- The length,
- With or without ring,
- With or without relief.

For the quote or production, a ring model, a template or a sketch featuring measurements is needed.

Straight smooth profiles

Standard hand rails

1227



Standard formats (mm)
200 250



1228

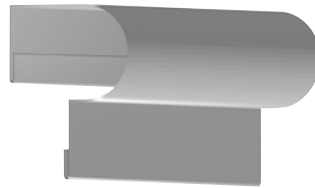

Standard formats (mm)
250 333

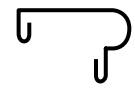

1229

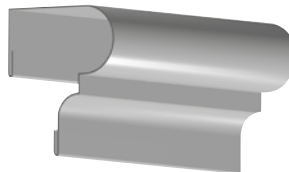

Standard formats (mm)
250 333

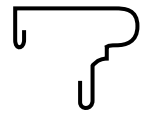

Rings



1230

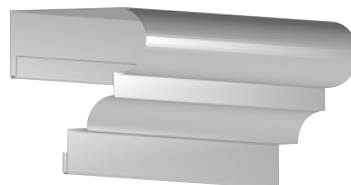

Standard formats (mm)
250 333

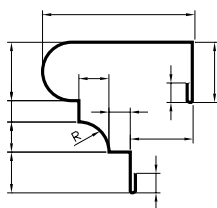
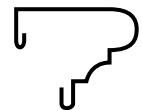

The standard hand rails are available in the formats given above. For hand rails of another format or made to model, indicate:

- The type or appearance of the metal,
- The thickness,
- The format,
- The length,
- With or without ring,
- With or without relief.

For the quote or production, a ring model, a template or a sketch featuring measurements is needed.

Curved smooth profiles



Cover strip



Gutter fronts



Hand rails



Gutters



Profile to your model

Gutters



For curved profiles, indicate:

- The type or aspect of the metal,
- The format,
- The length,
- With or without ring,
- The r curve radius on the backslash.

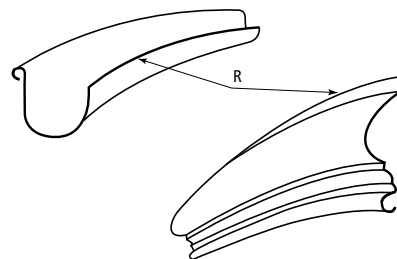

Standard stamped profiles

Cover strips



2257

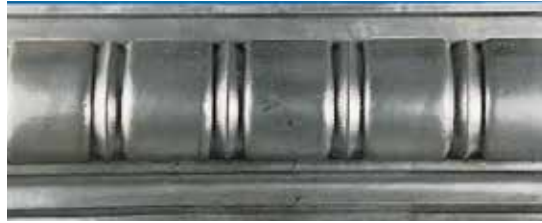

4244



4251

Ref.	Height (cm)	Working length (mm)	Depth (mm)	Aspects
2257	21	960	60	<div style="display: flex; align-items: center;"> <div style="width: 15px; height: 10px; background-color: #d3d3d3; margin-right: 5px;"></div> Natural zinc </div> <div style="display: flex; align-items: center; margin-top: 5px;"> <div style="width: 15px; height: 10px; background-color: #b8860b; margin-right: 5px;"></div> Copper </div>
	27	970	90	
	33	1020	110	
4244	25	940	80	<div style="display: flex; align-items: center;"> <div style="width: 15px; height: 10px; background-color: #d3d3d3; margin-right: 5px;"></div> <div style="width: 15px; height: 10px; background-color: #b8860b; margin-right: 5px; margin-left: 10px;"></div> <div style="width: 15px; height: 10px; background-color: #808080; margin-right: 5px; margin-left: 10px;"></div> <div style="width: 15px; height: 10px; background-color: #a9a9a9; margin-left: 10px;"></div> </div>
4251	27	960	60	<div style="display: flex; align-items: center;"> <div style="width: 15px; height: 10px; background-color: #d3d3d3; margin-right: 5px;"></div> <div style="width: 15px; height: 10px; background-color: #b8860b; margin-left: 10px;"></div> </div>

Gutter fronts - Escutcheons



4272



4273



4395

Ref.	Height (cm)	Working length (mm)	Depth (mm)	Aspects
4272	36	995	33	<div style="display: flex; align-items: center;"> <div style="width: 15px; height: 10px; background-color: #d3d3d3; margin-right: 5px;"></div> Natural zinc </div> <div style="display: flex; align-items: center; margin-top: 5px;"> <div style="width: 15px; height: 10px; background-color: #b8860b; margin-right: 5px;"></div> Copper </div>
4273	41	960	70	
4395	50	-	90	

Stamped designs

Stamped roof designs are the heart of VMZINC® know-how: their finesse and variety are a reference on the market. Requiring the use of a special alloy, the production of stamped designs requires up to ten different operations to take the shape of a ridge, an acanthus leaf, a escutcheon, or a face.



> Stamped designs	62
Standard double ridges	62
> Standard stamped designs	67
Awnings	68
Valances	68
Hips and beads	69
Roses	69
Leaves	70
Heads	70

Stamped designs



*Château de Madrid, Neuilly-sur-Seine (France)**



*Versailles (France)**

* Bespoke model

Stamped designs



*Theatre, Quimper (France)**



*Saint-Augustin church, Paris (France)**



*Stamped ridge**

* Bespoke model

Stamped designs



Restaurant, Lyon (France)*



Versailles (France)*

* Modèle sur mesure

Stamped designs



*Lion head, escutcheon**



*Stamped ridge**



*Brittany parliament, Rennes (France)**

* Bespoke model

Standard stamped designs

Standard double ridges



2085



2255



2506



2615



4022

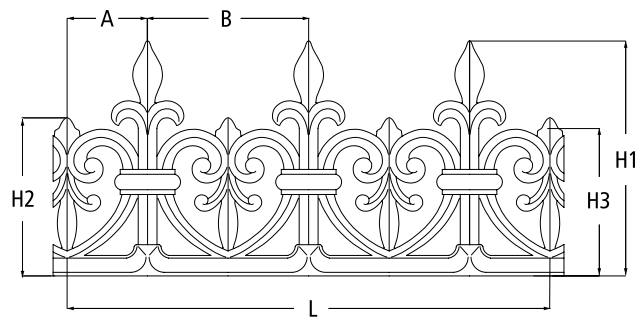

Ref.	H1	L	B	A	H2	H3	Fixing rod diameter ** (mm)	Aspects
	Height (mm)	Working length* (mm)	Spacing (mm)	Leader length (mm)	Frieze height (mm)	Fixing rod penetration height (mm)		
2085	270	950	190	95	180	240	12	■ ■
2255	300	970	245	122,5	260	255	10	■ ■ ■
2506	400	770	385	192,5	310	383	16	■ ■
2615	215	960	160	80	150	155	10	■ ■
	350	940	240	120	240	240	12	■ ■
2710	380	875	295	147,5	315	370	10	■ ■
4020	900	945	480	480	500	830	16	■ ■
4022	700	1140	380	380	420	680	16	■ ■
4033	500	945	315	157,5	360	480	14	■ ■ ■
4042	300	960	240	120	175	280	12	■ ■ ■

* The working length can vary by +/- 10 mm // ** Rod supplied on request

Standard stamped designs

Standard double ridges



2710



4042



4020



4033

Single side galleries



1675



2185



1850



2045



2241



4676

Ref.	Height (mm)	Working length* (mm)	Spacing (mm)	Frieze height (mm)	Aspects
1675	150	930	235	115	<div style="display: flex; align-items: center;"> <div style="width: 15px; height: 10px; background-color: #cccccc; margin-right: 5px;"></div> Natural zinc <div style="width: 15px; height: 10px; background-color: #800000; margin-left: 10px; margin-right: 5px;"></div> Copper </div>
1850	130	950	160	95	
2045	80	950	75	55	
2185	155	1000	145	115	
2241	120	980	122	70	
4676	185	960	195	100	

* The working length can vary by +/- 10 mm

Standard stamped designs

Awnings



2155

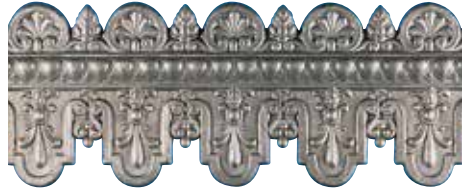

2178

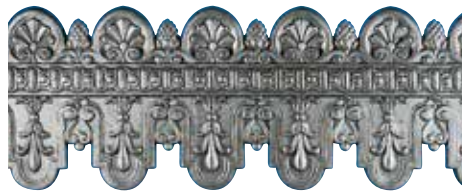

2179

Ref.	Height (mm)	Working length (mm)	Spacing (mm)	Upper frieze height (mm)	Lower frieze height (mm)	Aspects
2155	190	1010	110	42	125	<input type="checkbox"/> Natural zinc <input checked="" type="checkbox"/> Copper <input checked="" type="checkbox"/> QUARTZ-ZINC®
2178	220	987	122	130	60	<input checked="" type="checkbox"/> QUARTZ-ZINC®
2179	320	953	155	100	165	<input checked="" type="checkbox"/> QUARTZ-ZINC®

* The working length can vary by +/- 10 mm

Valances



2834

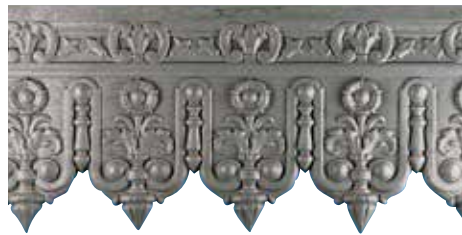

4668

Ref.	Height (mm)	Working length (mm)	Spacing (mm)	Upper frieze height (mm)	Lower frieze height (mm)	Aspects
2834	350	1037	122	75	220	<input type="checkbox"/> Natural zinc <input checked="" type="checkbox"/> Copper <input checked="" type="checkbox"/> QUARTZ-ZINC®
4668	400	987	190	-	370	<input type="checkbox"/> Natural zinc <input checked="" type="checkbox"/> Copper

* Working length kann um +/- 10 mm schwanken

Standard stamped designs

Hips and beads

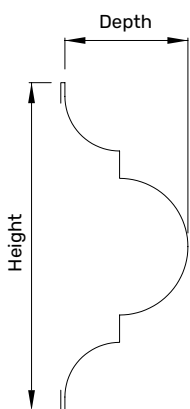

Ref.	Height (mm)	Working length* (mm)	Depth (mm)	Aspects
2427	130	1060	47	<input type="checkbox"/> Natural zinc <input checked="" type="checkbox"/> Copper
	150	1065	50	
	195	1030		
2507	30	1065	13	<input type="checkbox"/> <input checked="" type="checkbox"/> <input type="checkbox"/>
	65	910		
	90	1020		
2508	50	1065	15	<input type="checkbox"/> <input checked="" type="checkbox"/> <input type="checkbox"/>
	70	1005		

* The working length can vary by +/- 10 mm

Roses



3097



3098



3099



4451

Ref.	Diameter (cm)	Aspects
3097	7	<input type="checkbox"/> Natural zinc <input checked="" type="checkbox"/> Copper
	10	
3098	18	<input checked="" type="checkbox"/> QUARTZ-ZINC®

Ref.	Diameter (cm)	Aspects
3099	11	<input type="checkbox"/> Natural zinc <input checked="" type="checkbox"/> Copper <input type="checkbox"/> QUARTZ-ZINC®
	14	
	16	
4451	16	

Standard stamped designs

Leaves



2270

Ref.	Height (cm)	Aspects
2270	72	<input type="checkbox"/> Natural zinc <input checked="" type="checkbox"/> Copper



2288

Ref.	Height (cm)	Aspects
2280	17	<input type="checkbox"/> Natural zinc <input checked="" type="checkbox"/> Copper
	23	
	50	

Heads



4329

Ref.	Height (cm)	Aspects
4329	23	<input type="checkbox"/> Natural zinc <input checked="" type="checkbox"/> Copper



4333

Ref.	Height (cm)	Aspects
4333	16	<input type="checkbox"/> Natural zinc <input checked="" type="checkbox"/> Copper

Roofing, facade and other products

Ornaments also have pride of place on roofs, facades and on rainwater downpipes.

Shingles, a proven and timeless system for facades and roofs return buildings to their bygone grandeur or give more recent projects modernity and innovation. Stamped panels, decorated facades and balustrades enhance the entire building with a unique style.



> Shingles

- Decorative, stamped shingles
- Soletos
- Bespoke stamped shingles
- Various format and aesthetic shingles
- Bespoke shingles
- Customised shingles

> Stamped standing seam

> Stamped panels

> Decorated facades

> Balustrades

72

72

73

74

75

77

78

79

80

81

> Other products

- Decorative pipes
- Ribbed bends
- Dolphin bends
- Gargoyles
- Semi-circular facade hopper heads
- Semi-circular corner hopper heads
- Ornamented hopper heads
- Zinc steps
- Stamped gutter

82

82

82

82

83

83

84

84

85

Shingles

Decorative stamped shingles

Type H shingles



Type F shingles



Reference	Code	Height (mm)	Width (mm)	Pieces/ m ²	Aspects
Type H	Zinc : 320006489 Copper : 320006490	330	180	44	<ul style="list-style-type: none"> <input type="checkbox"/> Natural zinc <input checked="" type="checkbox"/> Copper <input checked="" type="checkbox"/> QUARTZ-ZINC® <input checked="" type="checkbox"/> ANTHRA-ZINC® <input type="checkbox"/> AZENGAR® <input checked="" type="checkbox"/> PIGMENTO® green <input type="checkbox"/> PIGMENTO® red <input type="checkbox"/> PIGMENTO® blue <input type="checkbox"/> PIGMENTO® brown
Type F (different models)	Zinc: 320006489 Copper : 320006490	140 - 340	70 - 127	x	

Soletos

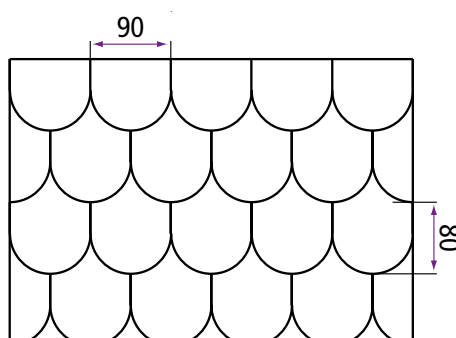

Reference	Thickness (mm)	Dimensions (mm)	Pieces/ m ²	Aspects
220021086	0.65	145X 210 mm	74	<input checked="" type="checkbox"/> QUARTZ-ZINC®
220021223	0.65	145X 210 mm	74	<input checked="" type="checkbox"/> ANTHRA-ZINC®

Classic soletto shingles are small and circular in appearance, suitable for renovation or pineapple type layouts. The fixing points overlap.

Shingles

Bespoke stamped shingles

Thanks to our production of stamping dies, our ornamental metal workers can mould their own dies and draw almost any design on the shingles. Our catalogue of historic stamping dies makes it possible for past centuries to come to life.









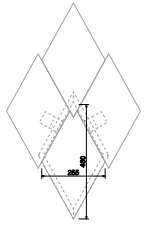

Old stamps on facade and roof ornaments.
Contact us for other stamped designs.

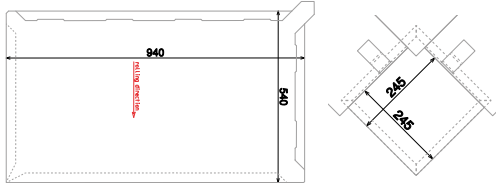

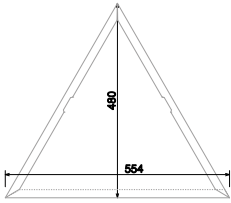
Shingles

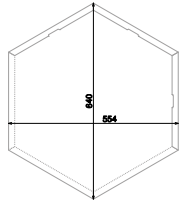
Various format and aesthetic shingles

Shape		
Diamond		
Square rectangular		
Triangle		
Hexagon		

Refer to the VMZINC® shingles prescription and installation guide or contact the VMZINC® teams for other shapes on request.



Schindeln

Bespoke shingles

Each project is different. For renovations or for new buildings, bespoke square, hexagonal or diamond shaped, or any other shaped shingles will decorate your facade or roof.

Reference	Item code	Aspects
Zinc	300001237	
Zinc clip	300001699	Natural zinc
Copper		Contact us
Copper clip		Copper

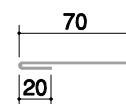
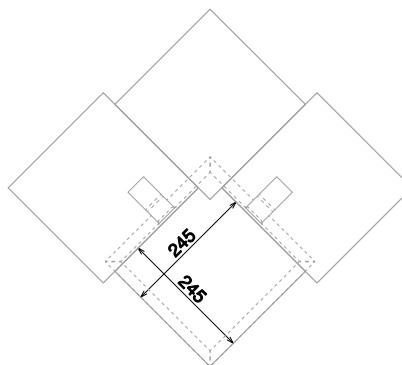
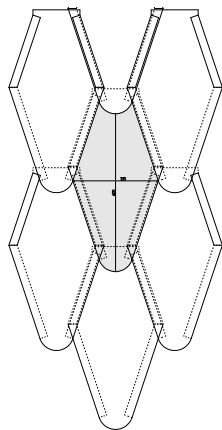

Stainless steel clip
Item code: 220023402

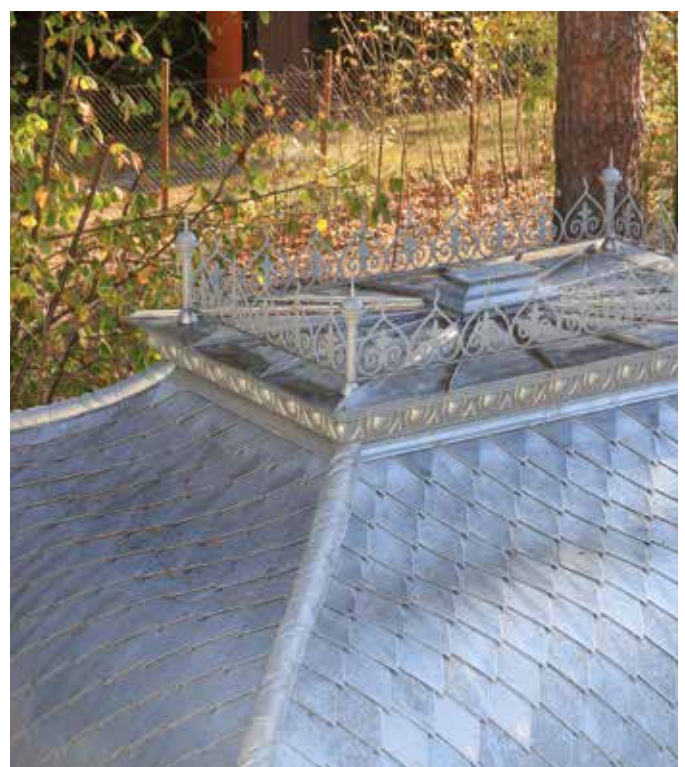

Shingles

Bespoke shingles



Schindeln

Customised shingles

Whatever the shape or combination of shingles you want, our design team will guide you to find the best option for the design you want.

For more information, contact VMZINC®.

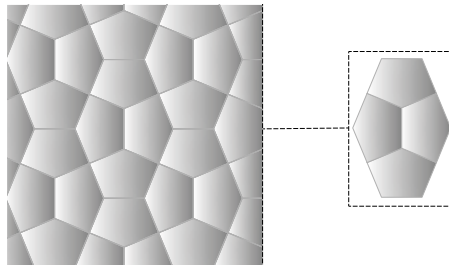
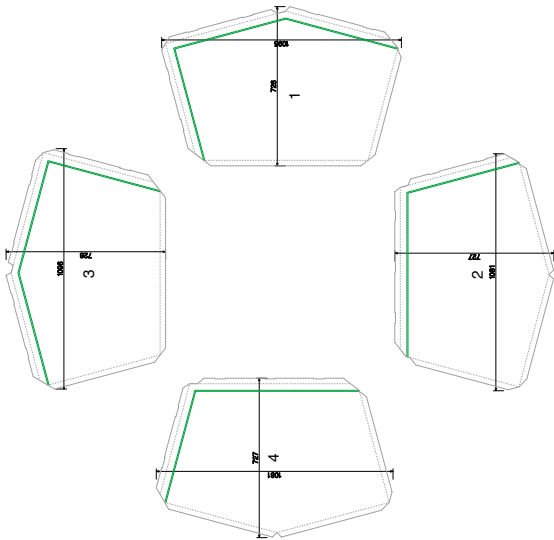

Stamped standing seam

Reference	Length (mm)	Width (mm)	Cover	Aspects
Stamped standing seam panel with rounded tile design	3000	600	1,55 m ²	<ul style="list-style-type: none"> <input type="checkbox"/> Natural zinc <input checked="" type="checkbox"/> Copper <input type="checkbox"/> QUARTZ-ZINC® <input type="checkbox"/> ANTHRA-ZINC® <input type="checkbox"/> AZENGAR® <input type="checkbox"/> PIGMENTO® green <input type="checkbox"/> PIGMENTO® red <input type="checkbox"/> PIGMENTO® blue <input type="checkbox"/> PIGMENTO® brown
Stamped standing seam panel design on request	3000	430- 600	1,1 - 1,55 m ²	depending on feasibility

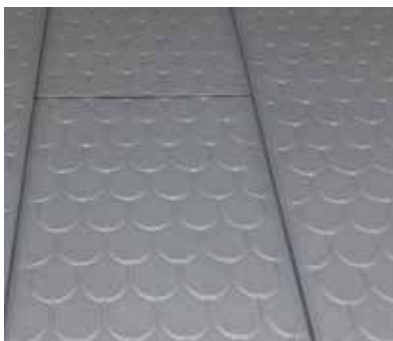

Sliding clip



Fixing clip



After crimping (double crimped standing seam)

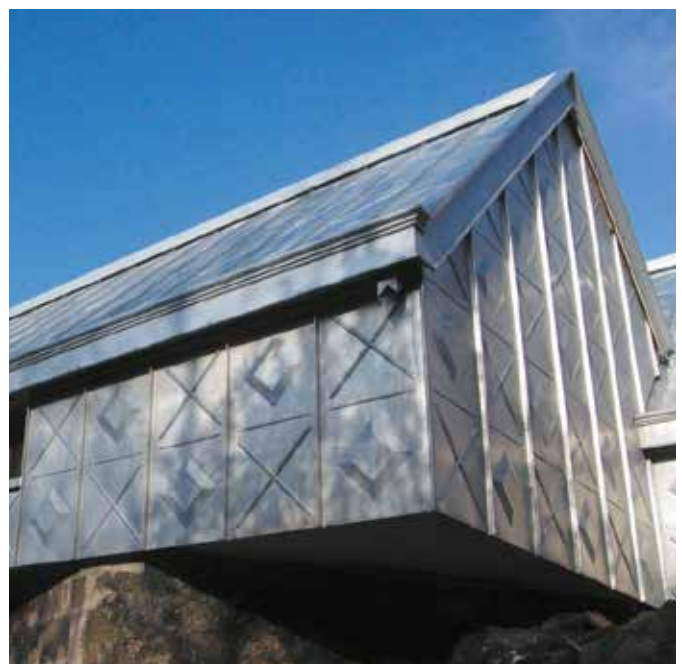

Stamped panels

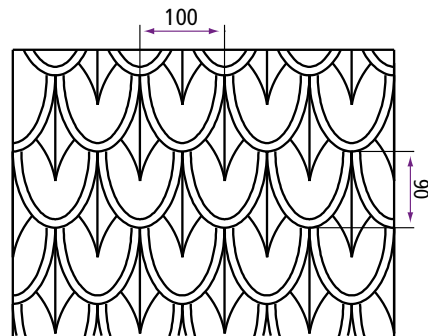
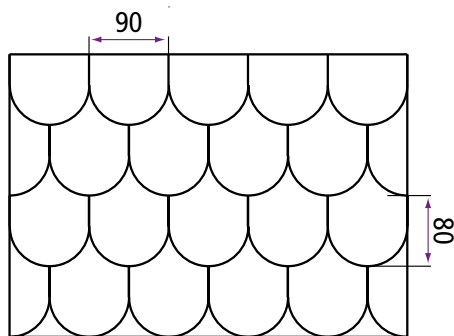
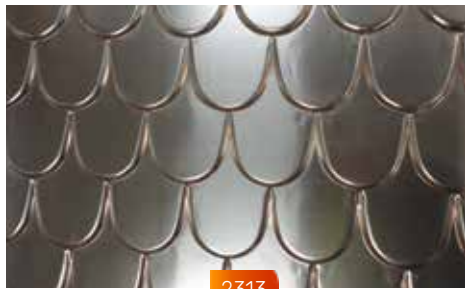

Ref.	Item code	Height (mm)	Width (mm)	Pieces/ m ²	Aspects
Panel 2313	Zinc 220003662 Copper 220006871	500	2000	0,75	<input type="checkbox"/> Natural zinc <input type="checkbox"/> Copper <input type="checkbox"/> QUARTZ-ZINC® <input type="checkbox"/> AZENGAR®
Panel 1965	Zinc 220003636 Copper 220006869 Natural zinc 320003798 Copper 320003801	500	2000	0,75	
Bespoke panel	Zinc 320006868	500	2000	0,75	



Decorated facades



The Ornamented facade panels are a unique line of bespoke ornamented facade panels. The infinite decoration possibilities inspire the world of renovation, new designs and visions, and new buildings.

The decoration solution line provides a large number of possible openings, perforations, formats, designs and appearances, from the most classic to the most modern. Thanks to the VMZINC® box supports, VMZINC® decorated facade panels are quick and easy to install.

The unique line of VMZINC® decorated facades and our design team will help bring your creation to life.

Modern embossed panel



Classic style decorated panel



Perforated panel



Cornice style panel



Balustrades

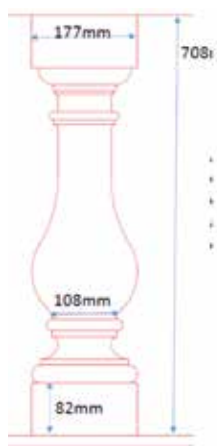

VMZINC® balustrades are a lightweight and bespoke solution to your renovation or new build project. They merge with the other building materials such as stone, lead, slate, etc.

We provide our support in the design of the supporting structure.

These top end decorative products are available in zinc and in copper.



Other products

Decorative pipes



4700



1873

Ribbed bends



2457

Dolphin bends



2458



Gargoyles



1148



2262

Ref.	Diameter (mm)	Length or height *or cross section (mm)	Aspects
4700	140 x 90	1000	<input type="checkbox"/> Natural zinc <input checked="" type="checkbox"/> Copper
1873	80 - 100 - 120	1000	
2457	80	72° bend	
	100	72° bend	
2458	80	Dolphin bend / Overhang 110	
	100	Dolphin bend / Overhang 185	
1148	60	200	
2262	40	135	
	80	280	
	100	300	

Other products



Semi-circular facade hopper heads

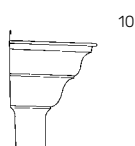

Reference	Ø (mm)	Standard	Aspects
205976000	80	NF	<input type="checkbox"/> Natural zinc <input checked="" type="checkbox"/> Copper
220019388	100	NF	
205978000	120	NF	<input checked="" type="checkbox"/> QUARTZ-ZINC® <input checked="" type="checkbox"/> ANTHRA-ZINC®
220007141	80	NF	
220007143	80	NF	

NF P 36-403 standard

Semi-circular corner hopper heads



Reference	Ø (mm)	Aspects
205979000	80	<input type="checkbox"/> Natural zinc
220019391	100	
220007142	80	<input checked="" type="checkbox"/> QUARTZ-ZINC®
220007149	80	

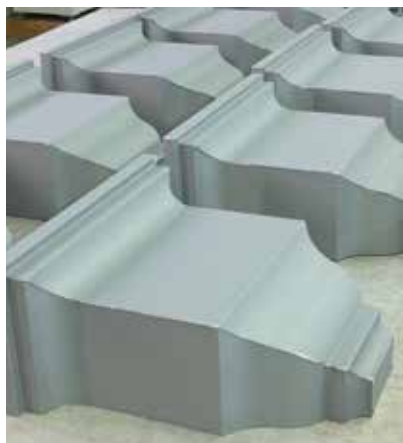

Other products

Ornamented hopper heads are often the final signature of the rainwater collection system. Standard or bespoke, they are also the link between the roof and the rainwater downpipes.

Ornamented hopper heads



4707



2279



2286

Ref.	Diameter (mm)	Length or height *or cross section (mm)	Aspects
4707	80	250 x 77 + 104 + 104 + 104 + 77	<input type="checkbox"/> Natural zinc <input type="checkbox"/> Copper <input type="checkbox"/> QUARTZ-ZINC® <input type="checkbox"/> ANTHRA-ZINC® <input type="checkbox"/> AZENGAR®
	100	280 x 93 + 116 + 116 + 116 + 93	
	120	300 x 117 + 124 + 124 + 124 + 117	
2279	80	285 x 190	<input type="checkbox"/> <input type="checkbox"/>
	100	295 x 207	
	120	320 x 230	
2286	80	240 x 170	<input type="checkbox"/> <input type="checkbox"/>
	100	300 x 210	
	120	345 x 240	



Zinc steps



1401 - 1402



Ref.	Molten zinc step	Step dimensions	Aspect
1401	with small cup for 22° to 35° pitch	265 x 190 depth	<input type="checkbox"/> Natural zinc
1402	with large cup for 36° to 54° pitch	265 x 190 depth	

To order zinc steps, it is imperative to indicate the roof pitch.

Other products

Stamped gutter



Designation	Aspect	Working length (cm)	Format (cm)
Ivy leaf semi-circular stamped gutter 501	■ QUARTZ-ZINC®	192	25

- Gutters compatible with size 25 accessories in the VMZINC® line
- 1 discrete hook every 40 cm.
- delivered in boxes of 5 lengths with the discrete hooks needed for their installation.

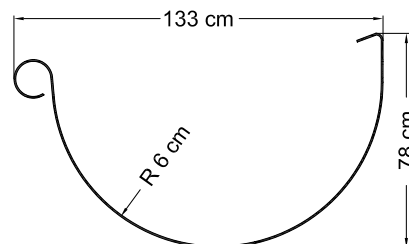



VMZINC

www.vmzinc.com
info@vmbuildingsolutions.com

VM BUILDING SOLUTIONS